

# Cables and Assemblies

# Cables and Accessories

Nylon Coated Galvanized Steel  
#2 – #3 – #4  
or Stainless.

Cut to length or per Cable Chart.

Please specify length in inches and tenths of an inch.  
Length tolerances are  $\pm 1/4"$  (up to 24").

Four Diameters are available in Steel.

Stainless is Special Order.

Add 'SC' after Part No. for Stainless Cable: UDB-X-SC-XX.X

C = CABLE CA = CABLE ASSEMBLY

\*\* 10 FEET OR 3 METERS MINIMUM LENGTH

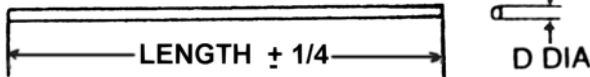
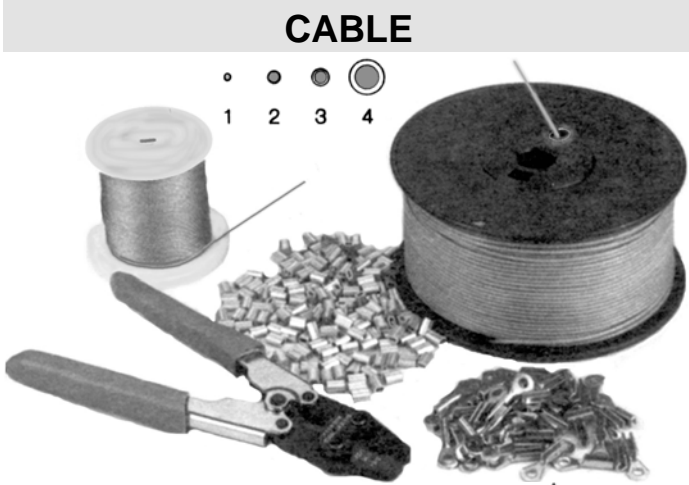

**UNITED Strength And Longevity**

LENGTH INCHES	LENGTH METRIC	LENGTH FEET **	LENGTH METER **	1000 FT ROLLS	D DIA COATED	D DIA UNCOATED	CONSTRUCTION	BREAKING STRENGTH - LBS
UDB-1-C-XX.X	UDB-1-C-XXX MM	UDB-1-C-XX FT	UDB-1-C-XX M	UDB-1-C- 1000 FT	.044	.024	1 x 7	80
UDB-2-C-XX.X	UDB-2-C-XXX MM	UDB-2-C-XX FT	UDB-2-C-XX M	UDB-2-C- 1000 FT	.062	.047	7 x 7	270
UDB-3-C-XX.X	UDB-3-C-XXX MM	UDB-3-C-XX FT	UDB-3-C-XX M	UDB-3-C- 1000 FT	.094	.062	7 x 7	480
UDB-4-C-XX.X	UDB-4-C-XXX MM	UDB-4-C-XX FT	UDB-4-C-XX M	UDB-4-C- 1000 FT	.187	.125	7 x 19	800

## CA — CABLE ASSEMBLIES

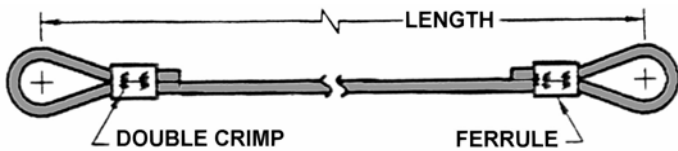

ASSEMBLY PART NO.	STOCK CABLE ASSEMBLIES			BREAKING STRENGTH IN LBS	FERRULE SIZES			
	LEN INCH	X LEN	CABLE		FERRULE PART NO.	ØA	ØB	C
UDB-710108	8.0	3.8	.062 - .067	270	UDB-2F	.138	.213	.335
UDB-710112	12.0	3.8	.062 - .067	270	UDB-2F	.138	.213	.335
UDB-710118	18.0	4.0	.092 - .094	480	UDB-3F	.185	.276	.374
UDB-710124	24.0	4.0	.092 - .094	480	UDB-3F	.185	.276	.374
UDB-710136	36.0	4.0	.092 - .094	480	UDB-3F	.185	.276	.374

## CABLE ASSEMBLY APPLICATIONS

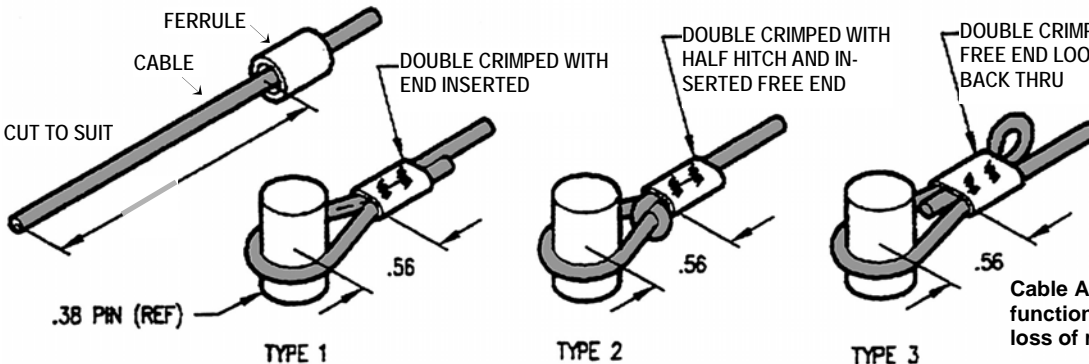

**'X' PLUS LENGTH IS EQUAL TO FREE LENGTH BEFORE ASSEMBLY.** See formula below.

Cable Assemblies from stock. The function of cables is to prevent the loss of removable parts.

## MANUAL CABLE CRIMPERS

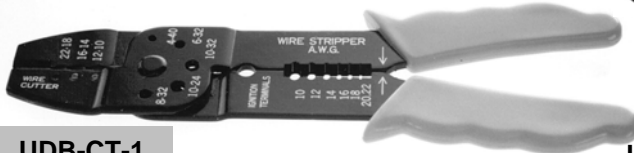

UDB-CT-1

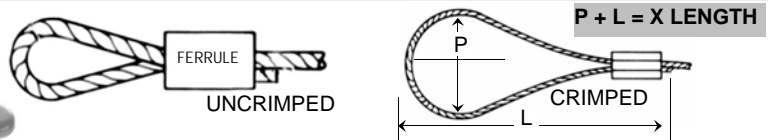

**UNITED Cable Crimpers**

Are designed for comfort and sure manual crimping. Measurements imprinted on Crimpers. Strong and Long Lasting. Use to crimp all ferrules on to nylon coated cables.

# Ferrules, Terminals, S-Hooks, Attachment Rings, Cable Tabs



DOUBLE FERRULE	SINGLE FERRULE	CABLE DIA NOM. DECIMAL	FITS CABLE SPECIFY LEN	A I. D. ± .007 FD FIG 8= 2 HOLES	B O.D. ± .007 FD WIDE x HT	C LEN ± .020
	UDB-1-F	3/64 - .044	UDB-1-C-XX.X	.094	.154	.315
UDB-1-FD		3/64 - .044	UDB-1FD-C-XX.X	.055	.144 x.201	.390
	UDB-2-F	1/16 - .063	UDB-2-C-XX.X	.138	.213	.335
UDB-2-FD		1/16 - .063	UDB-2FD-C-XX.X	.070	.175 x.217	.375
	UDB-3-F	1/16 - .063	UDB-3-C-XX.X	.185	.276	.374
UDB-3-FD		3/32 - .094	UDB-3FD-C-XX.X	.070	.175 x.217	.375
	UDB-4-F	3/32 - .094	UDB-4-C-XX.X	.138	.213	.591
UDB-4-FD		1/16 - .063	UDB-4FD-C-XX.X	.121	.281 x.188	.501
	UDB-5-F	3/32 - .094	UDB-5-C-XX.X	.185	.276	.827
UDB-5-FD		3/32 - .094	UDB-5FD-C-XX.X	.121	.281 x.188	.501
	UDB-6-F	3/16 - .188	UDB-6-C-XX.X	.378	.520	1.260
UDB-6-FD		3/16 - .188	UDB-6FD-C-XX.X	.188	.352 x.564	.564

## F – FD FERRULES

### SINGLE FERRULES AND STOP SLEEVES

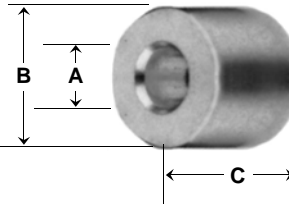

### DOUBLE OR DUAL FERRULES

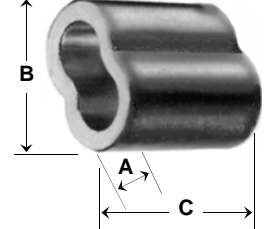

COPPER — ALUMINUM

GREATER CRIMPING AREA

## STEEL STAMPED MINIATURE EYE TERMINALS

TERMINAL PART NO.	FITS CABLE NOM ACTUAL	A DIA.	B FLANGE THICKNESS	C LENGTH EYE CENTER	D	E
UDB-TERM-1	3/64 - .044	.190	.716	.268	.063	.321
UDB-TERM-2	1/16 - .063	.260	.950	.335	.063	.439
UDB-TERM-3	3/32 - .094	.375	1.31	.450	.093	.750
UDB-TERM-4	3/16 - .188	.501	2.40	.490	.190	1.000

TO MOUNT UNITED CABLE ASSEMBLIES

## TERM EYE TERMINALS

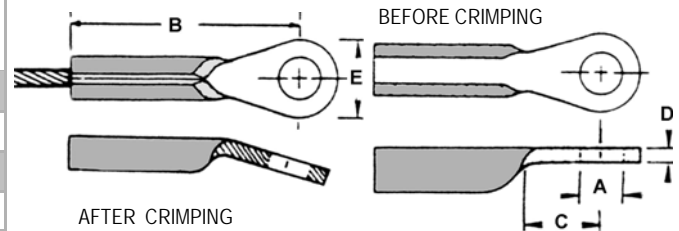

## DESIGNED FOR USE ON SF BUSHINGS, L and T BALL LOCK PINS

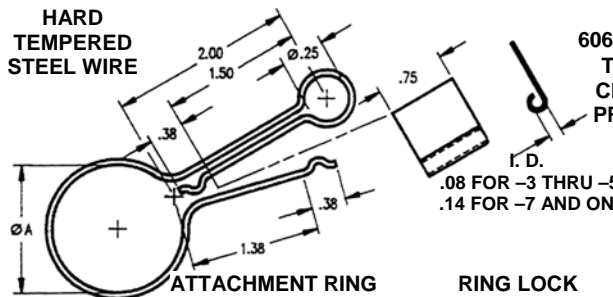

#6 TO #20 GAGE SIZE DEPENDENT

RING PART NO. (16ths)	ØA	RING PART NO. (16ths)	ØA
UDB-AR006	3/8	UDB-AR018	1-1/8
UDB-AR008	1/2	UDB-AR020	1-1/4
UDB-AR010	5/8	UDB-AR022	1-3/8
UDB-AR012	3/4	UDB-AR126	1-5/8
UDB-AR014	7/8	UDB-AR134	2-1/8
UDB-AR016	1"	UDB-AR142	2-5/8

## AR ATTACHMENT RINGS

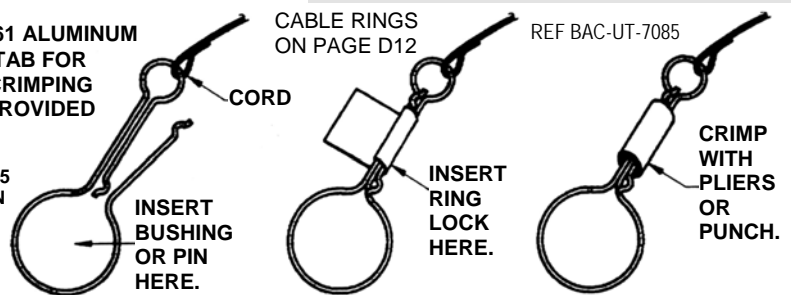

## ALUMINUM OR STAINLESS TABS

TAB PART NO.	MATERIAL	A OPEN HOLE DIA
UDB-TA-4	ALUM ALLOY	.130
UDB-TC-4	CRES 302	.130
UDB-TA-6	ALUM ALLOY	.195
UDB-TC-6	CRES 302	.195
UDB-TA-8	ALUM ALLOY	.281
UDB-TC-8	CRES 302	.281

## TA – TC CABLE TABS

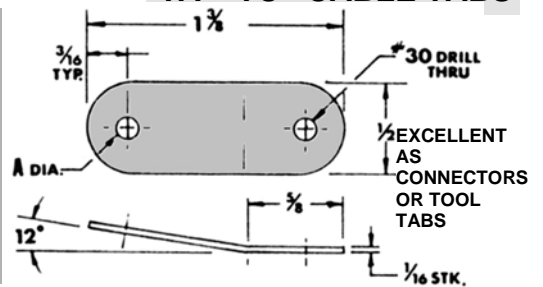

## STEEL 'S' HOOKS TO ATTACH ACCESSORIES WITH LOW LOAD LIMITS

S-HOOK PART NO.	TRADE SIZE NUMBER	WIRE SIZE INCHES	INSIDE LEN INCHES	LBS PER 100 PIECES	LOAD LIMIT LBS	LOAD LIMIT KGS.
UDB-20-SH	20	.080	27/32	5/16	16	7
UDB-21-SH	21	.080	11/16	1/4	16	7
UDB-40-SH	40	.134	1"	1"	42	19
UDB-72-SH	72	.225	1-1/2	4-3/4	130	59

NO. 40

## SH S – HOOKS



DO NOT USE FOR OVERHEAD LIFTING.

## UDB Cable Assemblies

# Cable Assemblies

For material, types and sizes, see pages D12, D14 and D15.

**UNITED Cable Assemblies are strong, efficient, flexible, economical! They prevent the loss of removable fixture parts. UDB Cables are light blue or clear nylon coated flexible stranded wire. We have eleven types of cable, four cable diameters and minimum cable assembly length is three inches. All cable assemblies are prefixed CA.**

Type 1		Loop to fit. One end open.
Type 2		Loops to fit. Both ends.
Type 3		CR — Ring to fit. Other end open.
Type 4		CR — Ring to fit. Loop to fit other end.
Type 5		CR — Rings to fit. Both ends.
Type 6		AR — Ring to fit. Other end open.
Type 7		AR — Ring to fit. Loop to fit other end.
Type 8		AR — Rings to fit. Both ends.
Type 9		TRM — Terminals to fit. Other end open.
Type 10		TRM — Terminals to fit. Loop other end.
Type 11		TRM — Terminals to fit. Both ends.

### UDB ORDERING EXAMPLE:



UDB — 11 — 2 — CA — 24.5 — TRM-2 — TA-4

Type Assembly \_\_\_\_\_  
 Cable Size \_\_\_\_\_  
 Cable Assembly \_\_\_\_\_  
 Cable Length inches \_\_\_\_\_  
 Left Ring Type and I. D. in 16ths  
 or Right Ring Type and I. D. in 16ths \_\_\_\_\_  
 Cable Tab Number \_\_\_\_\_  
 Select Letter from one below: \_\_\_\_\_

L = Ferrule is to be left uncrimped on left end.  
 R = Ferrule is to be left uncrimped on right end.  
 LR = Ferrule is to be left uncrimped on left and right ends.

**UNITED  
 OFFERS  
 THE  
 GREATEST  
 SELECTION  
 IN  
 CABLES AND  
 CABLING  
 ASSEMBLIES.**

**YOU CAN  
 ORDER ANY  
 COMBINATION  
 YOU NEED!**

REFER TO PAGES  
 D12, D14, D15.

# Positive Ball Lock Pins

QUICK RELEASE PUSH BUTTON FLANGE PINS

**POSITIVE LOCK** Flange Pins have a **PUSH BUTTON** that starts ball action or retraction. This locking design has **QUICK RELEASE** and **SECURE FASTENING!** The quick release allows ease of removal and the double ball action design maintains retention.



**POSITIVE BALL LOCK FLANGE PINS**

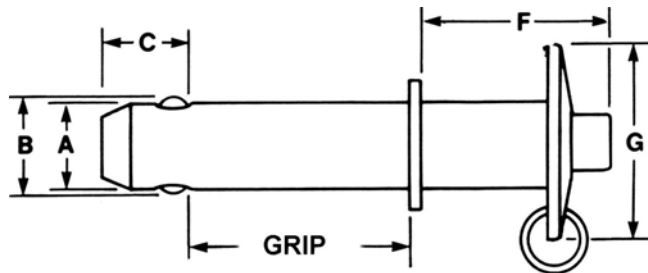

FURNISHED WITH SPLIT RING



**UNITED BALL LOCK PINS WITH FLANGE — BLPF**

This Unique Design incorporates a formed One-Piece Body and One-Piece Spindle.

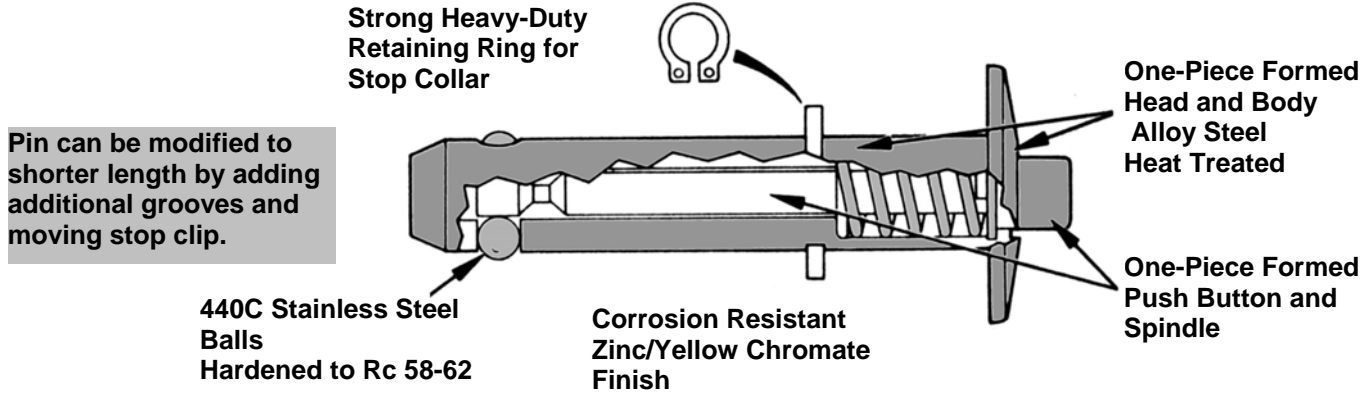

Heat Treated Alloy Steel for durability and long lasting strength with Zinc and Yellow Chromate finish. Other finishes available.

UNITED BLPF PART NO.	A DIA NOM.	A DIA ACTUAL	B BALL	C CHAM-FER	F	G	LENGTHS OF STANDARD STOCK SIZES												DOUBLE SHEAR LBS.			
							1/2	3/4	1"	1-1/4	1-1/2	1-3/4	2"	2-1/4	2-1/2	3"	3-1/4	4"				
UDB-BLPF-4-X.XX	1/4	.2455	.2485	.294 .289	.312	.870	.700	X	X	X	X	X										8,200
UDB-BLPF-5-X.XX	5/16	.3080	.3110	.380 .325	.312	.870	.800			X	X	X	X	X								12,800
UDB-BLPF-6-X.XX	3/8	.3705	.3735	.445 .440	.375	.900	.860			X	X	X	X	X	X	X						18,400
UDB-BLPF-8-X.XX	1/2	.4955	.4985	.599 .594	.437	1.125	1.000				X	X	X	X	X	X	X	X	X	X		32,800



# Safety Fast Pins

## Unlimited Applications

### SAFETY FAST PINS

Use for  
 Cord Holders, Metal Tag Holders,  
 Key Holders, Machine Tags, Job Identification Markers,  
 Tail Pins, Cable Pins, Cap Locks, Cover and Tarp Holders.

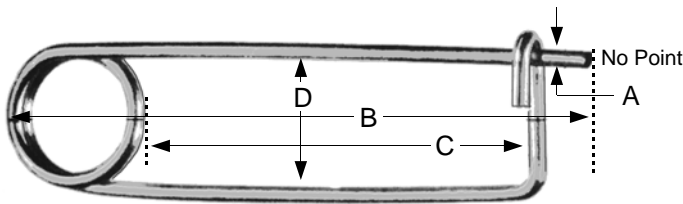

**UNITED's** Multi-Purpose Industrial Safety Pins satisfy most quick pinning requirements.

The large pins will couple a fork lift to a small trailer!  
 They help keep your electrical cords or hoses off the floor.

Send us your unique uses for these great pins.

Manufactured from durable spring steel and plated.

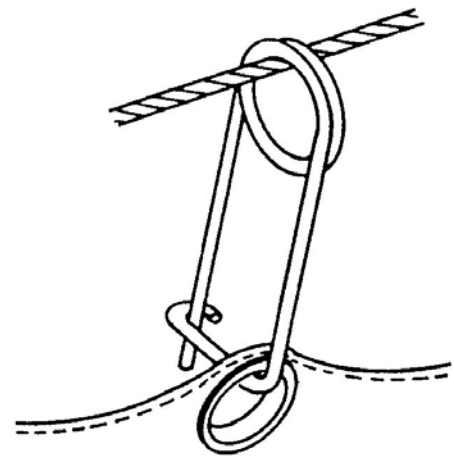
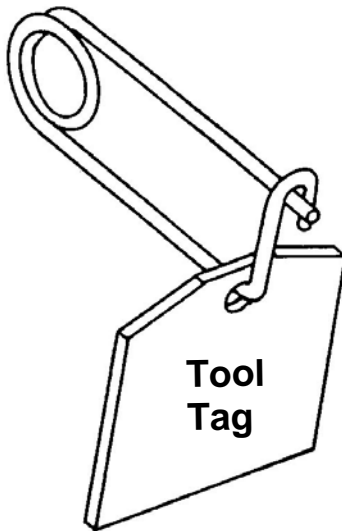
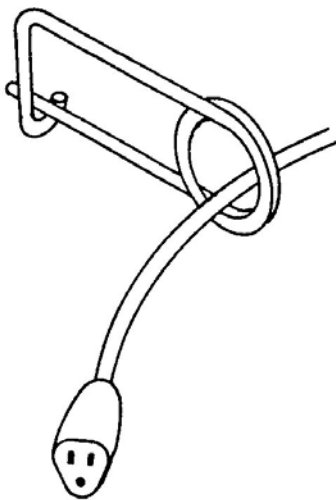

- **FAST**
- **SAFE**
- **STRONG**
- **LOW COST**

PART NO.	WIRE DIAMETER A	B	C	D
UDB-444401	.058	1-3/4	1-1/16	3/8
UDB-444402	.063	2-5/16	1-11/16	1/2
UDB-444403	.091	2-3/4	1-11/16	5/8
UDB-444404	.095	2-19/32	1-29/32	1/2
UDB-444405	.120	4-3/8	2-13/16	13/16
UDB-444406	.124	3-13/16	2-11/16	7/8
UDB-444407	.148	5-3/4	3-3/4	1-1/8
UDB-444408	.154	3-15/16	2-9/16	1-1/16

# Rigging Pins and Warning Streamers



## RIGGING PINS

Ordering Example:

**UDB - 937945 - 2 - 4.2 - K - SP - WS**

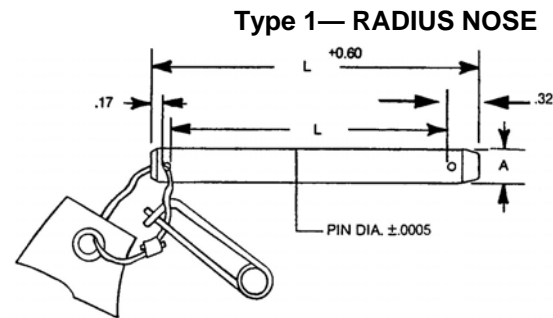
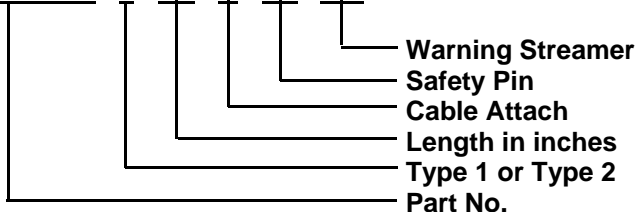

Send you Special Pin Rigging Dimensions.

**UNITED's High Tensile Strength Rigging Pins are used to temporarily replace fasteners while aircraft is under repair.**

**Precision ground from 303 stainless.**

**Provided with Safety Pins, Cable, and Warning Streamers as required.**

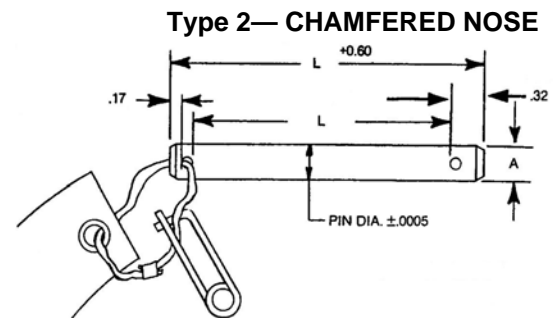
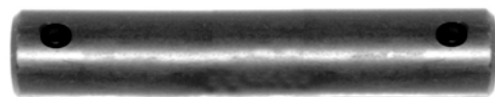

PART NO.	A ±.0005
UDB-937905	.1562
UDB-937910	.1875
UDB-937915	.2500
UDB-937920	.3125
UDB-937925	.3750
UDB-937930	.4375
UDB-937935	.5000
UDB-937940	.5625
UDB-937945	.6250
UDB-937950	.7500
UDB-937955	.8750
UDB-937960	1.000

## CUSTOMIZABLE WARNING STREAMERS

Ordering Example shown has 3" width & 60" length

**UDB-WS - xxx - xxx - xxx - P/C** (material)

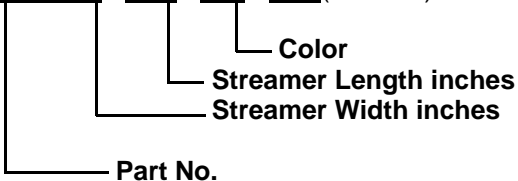

**UDB - WS - 3 - 60 - Red - P**

**MESSAGE & Letter Size: (Specify here)**

**FOR USE WITH RIGGING PINS, etc.**

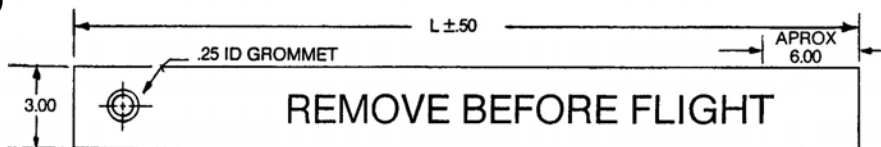

**MATERIAL:**

Plastic Webbing or Cotton Webbing  
Specify **P** (plastic) or **C** (cotton)  
Includes Grommet

**COLOR:**

**Red** is default color, if not stated.  
Specify if not RED. Alert Orange or Other (Call for other color availability).

**WORDING:**

"Remove Before Flight" wording shown in example above on one side and has "Return to Shop X-XXXX" on the other in 1" high letters. Special wording available.

# Spring Plungers and Pull Rings

# L-Handle Hand Retractable Spring Plungers & Pull Rings



**L- HANDLE LONG STROKE  
STAINLESS STEEL  
STAINLESS SPRING 17-4 P4  
Stainless in Long Stroke only**

## L- HANDLE HAND RETRACTABLE SPRING PLUNGERS—ALL U.S.A.

- ◆ Withdraws completely into body
- ◆ Locks in full retractable position when handle aligns with body slot
- ◆ Contains nylon patch locking element

### LONG STROKE — STANDARD LENGTH — LOCKING PLUNGERS

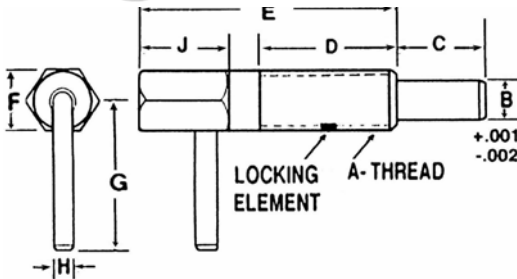

UNITED STEEL PART NO.	UNITED STAINLESS PART NO.	LBS—END PRESSURE START	LBS—END PRESSURE FULL	A THREAD	B +.001 - .002	C TRAVEL	D THD LEN	E BODY LEN	F HEX	G HANDLE LEN	H PIN DIA	J HEX LEN
UDB-951962	UDB-951972	.50	2.50	1/4-20	.156	3/8	5/8	1-1/4	1/4	5/8	3/32	1/2
UDB-951964	UDB-951974	.75	3.75	3/8-16	.250	9/16	1-1/16	2"	3/8	15/16	9/64	11/16
UDB-951966	UDB-951976	1.00	5.00	1/2-13	.312	3/4	1-1/8	2-1/8	1/2	1-1/4	3/16	3/4
UDB-951968	UDB-951978	1.00	5.00	5/8-11	.375	1"	1-3/4	3"	5/8	1-5/16	3/16	1-1/16

To engage Plunger, turn handle to line up with slot in body. Plunger is slightly tapered for easy alignment. Quick-Release Drive Wrench allows rapid installation.

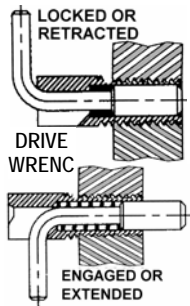

### "SHORTY" PLUNGERS



**L-HANDLE SHORT STROKE  
ZINC PLATED STEEL**

### SHORT STROKE — SHORT LENGTH — LOCKING PLUNGERS

UNITED PART NO. STEEL	UNITED PART NO. STAINLESS	LBS—END PRESSURE START	LBS—END PRESSURE FULL	A THREAD	B +.001 - .002	C TRAVEL	D THD LEN	E BODY LEN	F HEX	G HANDLE LEN	H PIN DIA	J HEX LEN
UDB-951922	UDB-951923	.125	.50	1/4-20	.156	3/16	7/16	3/4	1/4	9/16	3/32	1/4
UDB-951924	UDB-951934	.25	1.25	3/8-16	.250	5/16	5/8	1-1/8	3/8	3/4	9/64	3/8
UDB-951926	UDB-951936	.50	2.00	1/2-13	.312	13/32	7/8	1-1/2	1/2	1"	3/16	1/2
UDB-951928	UDB-951938	.75	2.50	5/8-11	.375	1/2	1-1/8	1-7/8	5/8	1-3/16	3/16	5/8

## PULL RING — HAND RETRACTABLE PLUNGERS—ALL U.S.A.

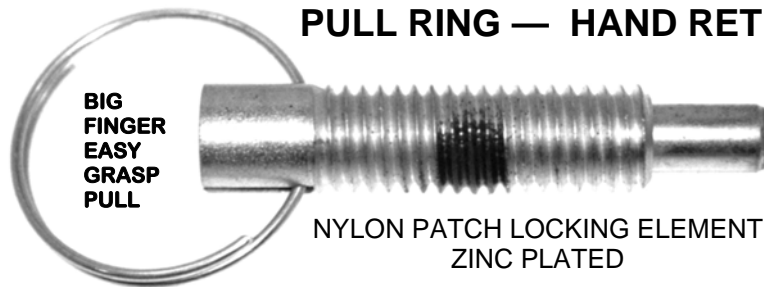

**BIG FINGER  
EASY GRASP  
PULL**

**NYLON PATCH LOCKING ELEMENT  
ZINC PLATED**

- ◆ Locks in retracted position when withdrawn completely into body
- ◆ Big Finger Ring provides easy access and convenient handling
- ◆ Fast Pull Action simplifies work in limited space applications

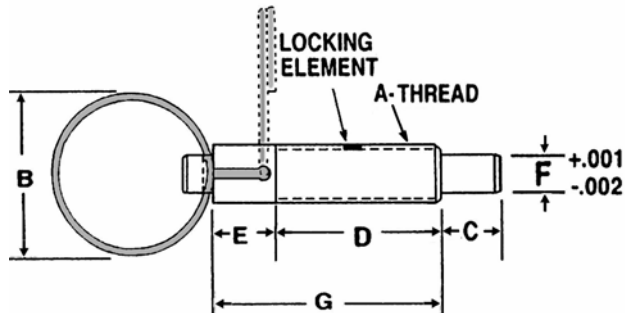

### PULL RING — STANDARD LENGTH — LOCKING PLUNGERS

UNITED PART NO. STEEL	UNITED PART NO. STAINLESS	LBS—END PRESSURE START	LBS—END PRESSURE FULL	A THREAD	B RING DIA	C TRAVEL	D THD LEN	E LOCK LEN	F +.001 - .002	G BODY LENGTH
UDB-951762	UDB-951763	1.0	2.5	1/4-20	1"	1/4	13/16	5/16	.156	1-1/8
UDB-951764	UDB-951765	2.0	4.0	3/8-16	1-1/4	3/8	1-1/4	7/16	.250	1-11/16
UDB-951766	UDB-951767	2.5	5.0	1/2-13	1-3/8	1/2	1-7/16	9/16	.312	2"

# Knurled Head Plungers and Big Finger Pull Rings

**Knurled Plungers  
and Short Pull Rings**

STEEL PLUNGERS and STAINLESS PLUNGERS

**STEEL:** Hardened Steel body with 17-7 PH Stainless Spring

**STAINLESS:** Stainless Steel 300 Series body with 17-7 PH Stainless Spring

**BOTH** are ZINC PLATED

End Pressures given in Pounds for U. S.A. and in Kilograms for Metric

AVAILABLE IN U.S.A. OR METRIC

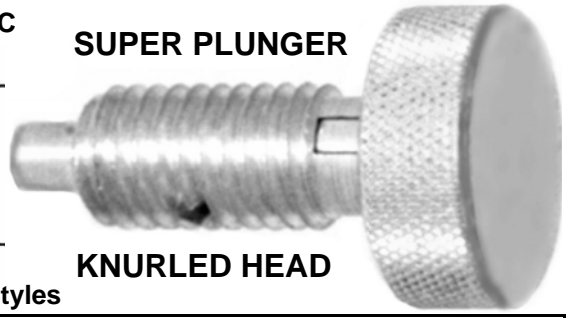
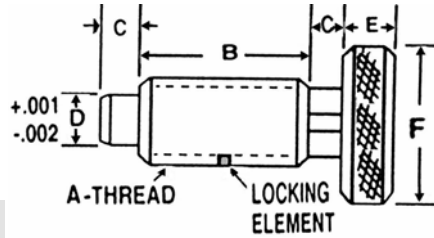

Both Heavy and Light Pressure Styles

HEAVY PRESSURE				LIGHT PRESSURE — KNURLED HEAD LOCKING PLUNGERS											U. S. A. DIM.
UNITED STEEL PART NO.	STAINLESS STEEL 300 PART NO.	LBS—END PRESSURE START FULL		UNITED STEEL PART NO.	STAINLESS STEEL 300 Series PART NO.	LBS—END PRESSURE START FULL	A THD	B BODY LEN	C TRAVEL	D +.001 - .002	E HEAD THICK	F HEAD DIA	NET LBS PER 100		
UDB-951810	UDB-951820	1.0	5.0	UDB-951815	UDB-951825	.50 2.5	1/4-20	1/2	1/8	.124	1/4	1/2	3		
UDB-951811	UDB-951821	1.5	6.0	UDB-951816	UDB-951826	.75 3.0	5/16-18	5/8	3/16	.155	9/32	5/8	5		
UDB-951812	UDB-951822	1.5	8.0	UDB-951817	UDB-951827	.75 4.0	3/8-16	3/4	7/32	.186	5/16	3/4	7		
UDB-951813	UDB-951823	2.5	10.0	UDB-951818	UDB-951828	1.25 5.0	1/2-13	7/8	1/4	.249	3/8	1"	13		

HEAVY PRESSURE			LIGHT PRESSURE — KNURLED HEAD LOCKING PLUNGERS											M E T R I C  DIMENSIONS
UNITED STEEL	KILOGRAMS—END PRESSURE START FULL		UNITED STEEL PART NO.	KILOGRAMS—END PRESSURE START FULL	A THD CLASS 6G ISO	B BODY LEN	C TRAVEL	D +.001 - .002	E HEAD THICK	F HEAD DIA	NET LBS PER 100			
UDB-951830	.45	2.27	UDB-951835	.225 1.135	M6x1.0	12.5	3.17	3	6.3	12.7	3			
UDB-951831	.68	2.72	UDB-951836	.340 1.360	M8x1.25	16.0	4.75	4	7.0	15.8	5			
UDB-951832	.68	3.63	UDB-951837	.340 1.815	M10x1.5	19.0	5.50	5	7.9	19.0	7			
UDB-951833	1.13	4.54	UDB-951838	.565 2.270	M12x1.75	22.0	6.35	6	9.4	25.4	13			

## Quick-Release Action

Manually retract and lock Super Plunger.

Pull back Knob and twist to lock in retracted position.

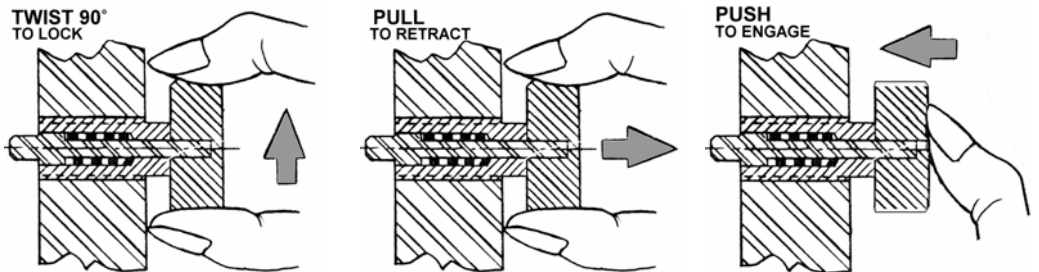

Slight taper on Super Plunger Tip allows instant alignment.

**PULL RING — COMPACT — SHORT — SPRING LOADED PLUNGER**  
**BIG FINGER RING for COMFORTABLE, FAST, PULL-EASY ACTION**

PULL RING — NON-LOCKING SHORT PLUNGERS										
UNITED PART NO.	LBS—END PRESSURE START FULL	A THD	B BODY LEN	C TRAVEL	D +.001 - .002	E HEX	F THD RELIEF	G	H LENGTH	RING O.D.
UDB-951702	.50 2.0	1/4-20	7/16	3/16	.156	1/4	1/32	5/32	9/32	3/4
UDB-951704	.75 3.0	3/8-16	5/8	9/32	.250	3/8	1/8	3/16	7/16	3/4
UDB-951706	1.00 4.0	1/2-13	13/16	3/8	.312	1/2	5/32	1/4	9/16	1"
UDB-951708	1.25 5.0	5/8-11	1"	7/16	.375	5/8	5/32	5/16	11/16	1"

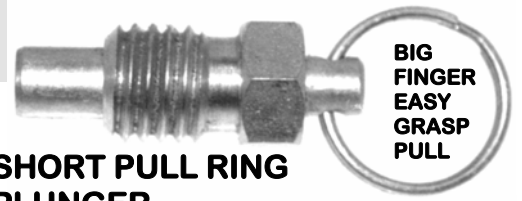

**SHORT PULL RING PLUNGER**

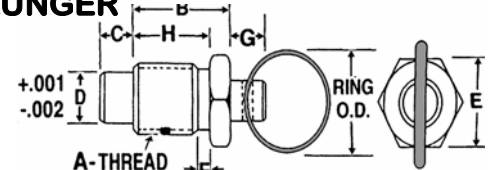

Pressure given in pounds. FULL Pressure = Force Lbs. required to move the Nose the distance given in Column C. Nose is chamfered at end, assuring easy alignment. USES: In Limited Space applications. Big Finger Ring makes holding the plunger back easy when changing the work piece.