

UCC-HL-1 HiLok Repair Kit

Hilok-HiTigue-Lockbolt-Rivet Production and Repair Kit

Rib-I Stacker Case



UCC-HL-1 PRODUCTION, REPAIR and TRANSFER HOLE KIT

This is a complete Kit for alignment, location, transfer, production and relocation of holes on irregular and straight surfaces using 90° perpendicularity to surfaces. Ideal for installation of HiLoks, Hitigue or Lock Bolts and Rivets.

Easy to LOCATE - ALIGN - SPOT - CLAMP - FASTEN IN PLACE - DRILL - REAM and INSERT NEW FASTENERS.

KIT CONTENTS



FIVE DRILL BARS—10 LOCK LINERS See Page C35.

QTY	UNITED PART NO.	DESCRIPTION
1	UDB-DBL-644896	Adjustable Drill Bar - STD 1/2"-3/4"
1	UDB-DBL-644864	Adjustable Drill Bar - Mini 1/2"-3/4"
1	UDB-DBL-6448120	Swivel Drill Bar-Double End 1/2"-3/4"
1	UDB-DBLRA-646464	Drill Bar - Right Angle 3/4"
1	UDB-DBLRA-484864	Drill Bar - Right Angle 1/2"



MIGHTY MINI UNI-LITE See Page C34.

1	UDB-HL-1-LITE	Bombsite Mini UniLite
1	UDB-HL-1-CASE	Rib-I Stacker Case Assy



EIGHT 1/2" OD SLIP FIT BUSHINGS 3/4" LONG I.D.s 3/16 thru M See pages A6-A9

EIGHT 3/4" OD SLIP FIT BUSHINGS 3/4" LONG I.D.s 5/16" to 3/8" See pages A6-A9.

1	UDB-SF32-12 .1860	.1860 x 1/2" x 3/4" SF Bushing
1	UDB-SF32-12 #8	.1990 x 1/2" x 3/4" SF Bushing
1	UDB-SF32-12 .2140	.2140 x 1/2" x 3/4" SF Bushing
1	UDB-SF32-12 .2295	.2295 x 1/2" x 3/4" SF Bushing
1	UDB-SF32-12 D	.2460 x 1/2" x 3/4" SF Bushing
1	UDB-SF32-12 G	.2610 x 1/2" x 3/4" SF Bushing
1	UDB-SF32-12 J	.2790 x 1/2" x 3/4" SF Bushing
1	UDB-SF32-12 .2920	.2920 x 1/2" x 3/4" SF Bushing
1	UDB-SF48-12 .3085	.3085 x 3/4" x 3/4" SF Bushing
1	UDB-SF48-12 P	.3230 x 3/4" x 3/4" SF Bushing
1	UDB-SF48-12 R	.3390 x 3/4" x 3/4" SF Bushing
1	UDB-SF48-12 8mm	.3543 x 3/4" x 3/4" SF Bushing
1	UDB-SF48-12 .3710	.3710 x 3/4" x 3/4" SF Bushing
1	UDB-SF48-12 W	.3860 x 3/4" x 3/4" SF Bushing
1	UDB-SF48-12 .4015	.4015 x 3/4" x 3/4" SF Bushing
1	UDB-SF48-12 .4170	.4170 x 3/4" x 3/4" SF Bushing



EIGHT BOMBSITES See Pages C30, C34.

1	UDB-SB322034 Nominal	Bombsite, 3/16" - 1/4" STD
1	UDB-SB322034-1OS	Bombsite, 3/16" - 1/4" 1st O/S
1	UDB-SB322034-2OS	Bombsite, 3/16" - 1/4" 2nd O/S
1	UDB-SB322034-3OS	Bombsite, 3/16" - 1/4" 3rd O/S
1	UDB-482056 Nominal	Bombsite, 5/16" - 3/8" STD
1	UDB-482056-1OS	Bombsite, 5/16" - 3/8" 1st O/S
1	UDB-482056-2OS	Bombsite, 5/16" - 3/8" 2nd O/S
1	UDB-482056-3OS	Bombsite, 5/16" - 3/8" 3rd O/S



See Page M3.

26 PRECISION GROUND LOCATING PINS - CENTER PUNCH POINTS

1	UDB-141860	.1860 Locating Alignment Punch
1	UDB-141990	.1990 Locating Alignment Punch
1	UDB-142140	.2140 Locating Alignment Punch
1	UDB-142295	.2295 Locating Alignment Punch
1	UDB-142460	.2460 Locating Alignment Punch
1	UDB-142610	.2610 Locating Alignment Punch
1	UDB-142770	.2770 Locating Alignment Punch
1	UDB-142920	.2920 Locating Alignment Punch
1	UDB-143085	.3085 Locating Alignment Punch
1	UDB-143230	.3230 Locating Alignment Punch
1	UDB-143390	.3390 Locating Alignment Punch
1	UDB-143543	.3543 Locating Alignment Punch
1	UDB-143710	.3710 Locating Alignment Punch
1	UDB-143860	.3860 Locating Alignment Punch
1	UDB-144015	.4015 Locating Alignment Punch
1	UDB-144170	.4170 Locating Alignment Punch

Align, Locate, Transfer Holes on Level or Irregular Surfaces - Assure Precision Locations and 90° Perpendicularity

Locate or Transfer Holes

1. IDENTIFY THE TRANSFER OR REWORK and hole diameter. Determine the direction you are installing or moving the hole.

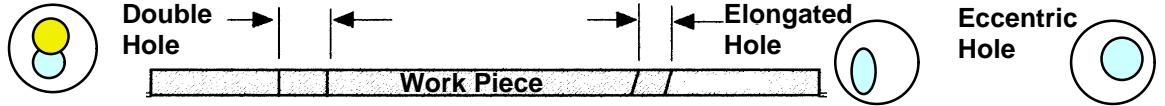

2. SELECT THE CORRECT DRILL BAR which satisfies your hole space and surface conditions. Use standard bars on level surfaces; select swivel bars for irregular or sloped surfaces.

3. CHOOSE THE BOMBSITE, ALIGNMENT PIN AND BUSHING consistent with your new, repaired or transferred hole. Locate and align the hole with the illuminating UniLite.

LOCATE AND ALIGN PRECISELY.

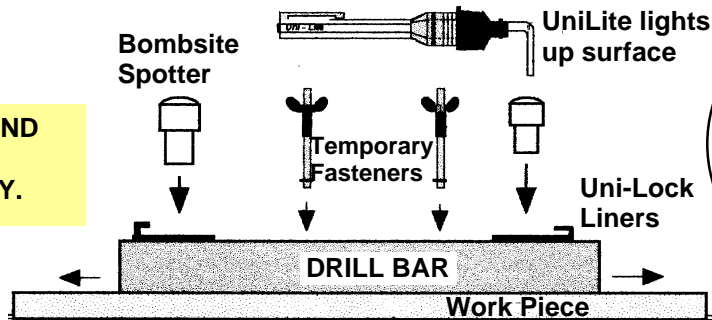

4. LIGHT CLAMP YOUR DRILL BAR. Adjust your locations finitely. If surface is irregular remove the Bombsite Spotter and use the specific Alignment Pin through a bushing to achieve 90° perpendicularity. You must satisfy the alignment and location. Clamp your Drill Bar to the workpiece or fixture using temporary fasteners from pages F11 and F12.

5. CLAMP POSITIVELY, REMOVE THE BOMBSITE SPOTTER AND INSTALL THE EXACT SF DRILL BUSHING by matching the bushing I.D. and/or the Alignment Pin size to the specific bombsite circle you used. Then lock in your SF Bushings. You are now ready.

REMOVE SPOTTER AND INSERT MATCHING SIZES OF SF BUSHINGS.

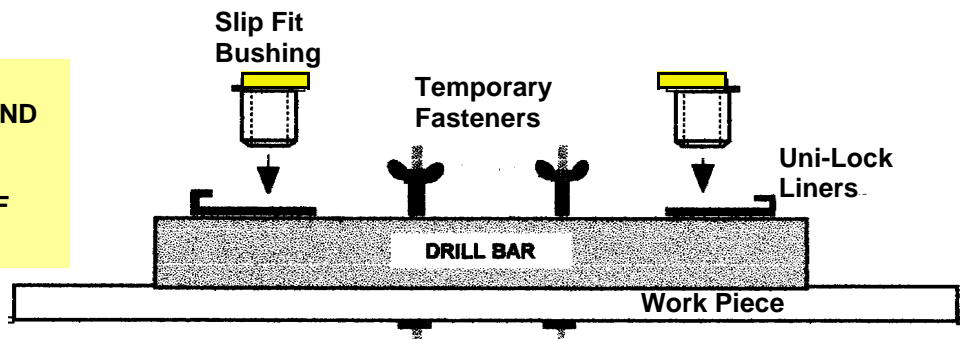

6A. YOUR DRILL BAR IS NOW LOCKED AND LOADED.

DRILL AND REAM CONFIDENTLY!

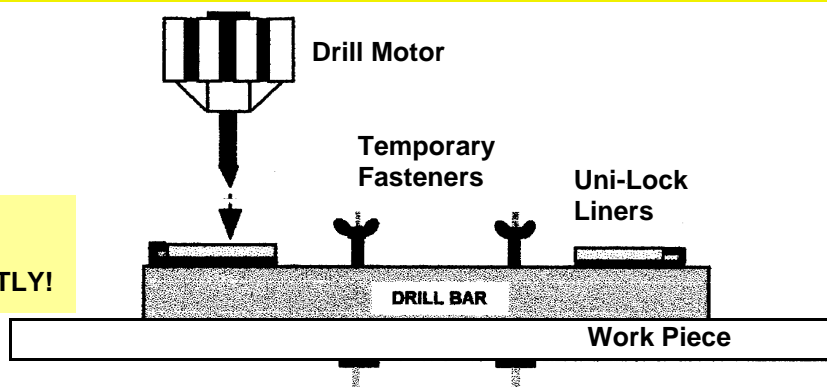

6B. DOUBLE CHECK YOUR NEW HOLE with the Alignment Pin and Bombsite Spotter.

INSPECT FOR PERPENDICULARITY.

YOUR HOLE PRODUCTION OR TRANSFER WILL BE A SUCCESS!

**Illuminating Bombsite
to Align Bushings**

Illuminate Your Bombsite Spotter

ALIGNMENT PIN—SF BUSHINGS—NEW ADJUSTABLE UNI-SWIVEL BAR

**USE MIGHTY MINI
UNI-LITE TO LIGHT
UP SPOTTER**



UNITED'S NEW MIGHTY MINI "UNI-LITE"

UNITED'S new UniLite offers maximum illumination at minimum expense. Simply attach the Right Angle Illuminator to the front of the UniLite, twist the barrel of the light, and PRESTO!—You have a dramatic illumination.

Position at the top edge of the Spotter without obstructing you view. The location is illuminated and you are assured accuracy. We think you will like adding light to your work!

EIGHT BOMBSITE SPOTTERS ARE AVAILABLE with hole circles two each hole in standard sizes 3/16" - 1/4" - 5/16" - 3/8" and first, second and third oversize holes (Refer to page C30 for 1/2" and 3/4" Bombsite Spotters available with single circles and crosshair bombsites).

SB-322034 STD	SB-322034-1OS 1 O/S	SB-322034-2OS 2 O/S	SB-322034-3OS 3 O/S	See Page 78.	SB-482056 STD	SB-482056-1OS 1 O/S	SB-482056-2OS 2 O/S	SB-482056-3OS 3 O/S
CIRCLES: 3/16-STD-.1860 1/4-STD-.2450	3/16-1 O/S-.1975 1/4-1 O/S-.2600	3/16-2 O/S-.2138 1/4-2 O/S-.2768	3/16-3 O/S-.2285 1/4-3 O/S-.2910		5/16-STD-.3075 3/8-STD-.3700	5/16-1 O/S-.3225 3/8-1 O/S-.3858	5/16-2 O/S-.3380 3/8-2 O/S-.4005	5/16-3 O/S-.3535 3/8-3 O/S-.4160

SIXTEEN CONCENTRIC CENTER PUNCH ALIGNMENT PINS precision ground to nominal minus .0005 in sizes from 3/16" to 27/64" available to locate your holes precisely!

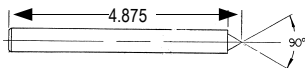

See Page M3.



ADJUSTABLE UNI-SWIVEL DRILL BAR with Alignment Pins will assure your 90° perpendicularity.

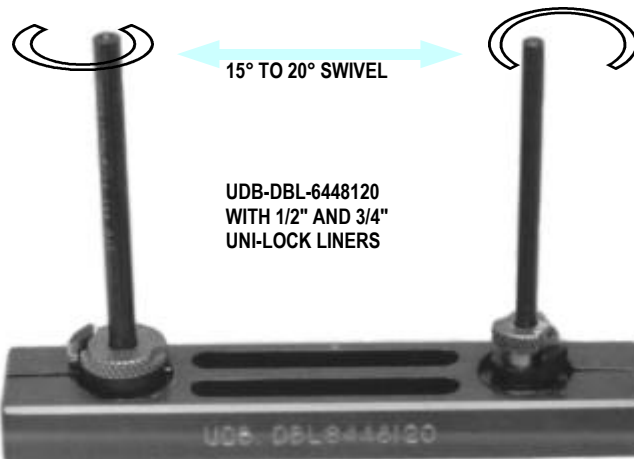

**1/2" AND 3/4"
UNILOCK LINER
HOLES TO
INSERT**

UDB-DBL-6448120
WITH 1/2" AND 3/4"
UNI-LOCK LINERS



Place UniLite at top edge of Bombsite to view with good illumination.

See Page C30.

Align, Locate, Produce and Transfer Holes



RIGHT ANGLE DRILL BARS avoid obstacles and locate around fasteners. The right angle tool for the right job! UDB-DBLRA-484864-1/2.

Manufactured in two hole sizes: 1/2" and 3/4" for Slip-Fixed 1/2" and 3/4" O.D. Bushings. Has two 5/16" wide clamping slots, allowing maximum clamping possibilities.

Offers clamping positions of 90° - 180° - 360°. Use with temporary fasteners shown on pages F11-F12, C-clamps or bolts and nuts.

Hard anodized blue aluminum. Available in steel. Black oxide with swivel. Four inches small. Available with swivel. Rotate 90° for Left Angle!

RIGHT ANGLE DRILL BARS 1/2" AND 3/4"

* UDB-DBLRA-484864
TWO 1/2" UNILOCK LINERS

* UDB-DBLRA-646464
TWO 3/4" UNILOCK LINERS

UDB-DBLRA-484864
ONE 1/2" AND ONE 3/4" UNILOCK LINERS

* Most practical for Right Angle Drill Bars.



UNI-MINI DRILL BARS 1/2" and 3/4" UniLock Liners. Also available with two 1/2" UL Liners or two 3/4" UL Liners. UDB-DBL-644864-1/2-3/4.

Has two 5/16" wide clamping slots. Hard anodized blue aluminum. Available in steel. Also available with swivel.

UDB-DBL-484864 TWO 1/2" UNILOCK LINERS
UDB-DBL-646464 TWO 3/4" UNILOCK LINERS
UDB-DBL-644864 ONE 1/2" AND ONE 3/4" UNILOCK LINERS

UNI-MINI DRILL BARS 1/2" AND 3/4"

STRONG ALUMINUM BARS

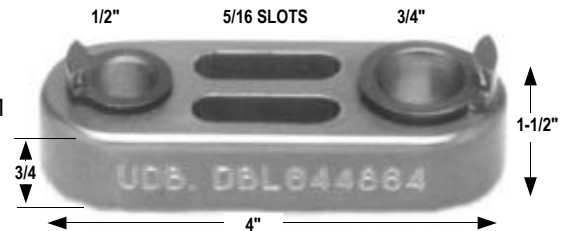

UNITED STANDARD 1/2" & 3/4" DRILL BARS with 1/2" and 3/4" UniLock Liners.

Also available with two 1/2" UL Liners or two 3/4" UL Liners for Slip-Fixed Renewable Bushings. Six inches long, 3/4" thick with radius ends for maximum access to all locations.

Two 5/16" wide clamping slots provide maximum clamping opportunities with minimum interference. Hard anodized blue aluminum. Available in steel. Available with swivel.

UDB-DBL-644896 STD 1/2" & 3/4" UNILOCK LINERS
UDB-DBL-484896 STD BAR with TWO 1/2" UL LINERS
UDB-DBL-646496 STD BAR with TWO 3/4" UL LINERS

STANDARD DRILL BARS 1/2" AND 3/4"

STRONG ALUMINUM BARS

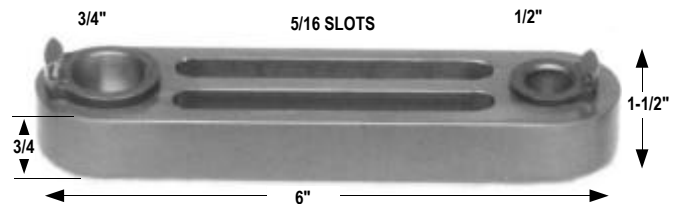

UNITED'S ADJUSTABLE DRILL BARS
This 7-1/2" Hard anodized blue aluminum drill bar has two swivel balls with 3/4" and 1" I.D.s.

We provide 1/2" and 3/4" UniLock Liners pressed into the swivel balls for immediate use with Slip-Fixed Renewable Bushings 1/2" and 3/4" O.D.

The Adjustable Bar allows Liners to rotate 360° and swivel 15°-20° in any direction.

Once loaded and clamped in place, you will achieve repeated holes 90° to your surface. Available in steel.

UNITED'S NEW ADJUSTABLE SWIVEL DRILL BARS With 1/2" & 3/4" UNI-LOCK LINERS

STRONG ALUMINUM BARS

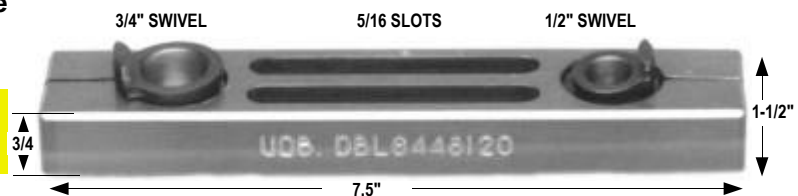

UDB-DBLS-6448120 with 1/2" & 3/4" I.D.
Non-Swivel Bars are also available.

Hole Production Kit

Hole Alignment-Location-Production & Transfer Kit

FOR 747 STRUT PROJECT

Rib-I
Stacker
Case

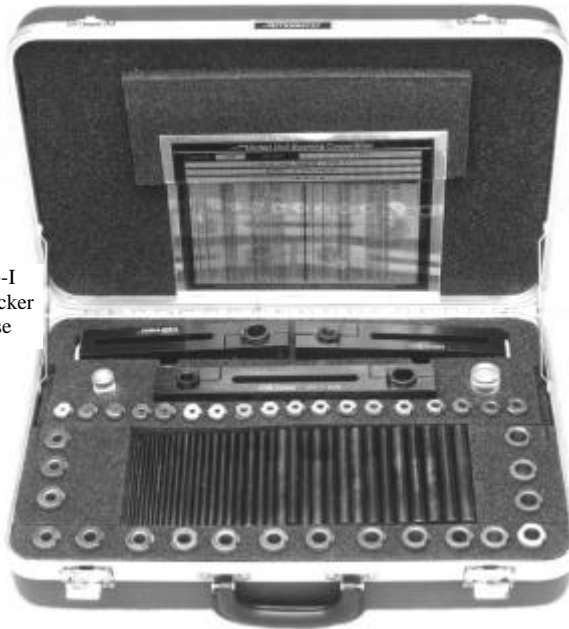

UTK 994747 HOLE ALIGNMENT-LOCATION- PRODUCTION-TRANSFER KIT

This Kit contains three Drill Bars, two Bombsite Spotters, thirty-six Slip-Fit Renewable Drill Bushings.

The thirty-six Alignment-Center Punches correspond to the Bushing I.D.s from #30 to 5/8 for a total of 78 kit items.

Ideal for fast and simple hole location!

KIT CONTENTS

ITEM	QTY	PART NUMBER	DESCRIPTION
1	1	UDB-991032	SWIVEL BAR ASSY- SINGLE END-1/2" I.D. UNILOCK LINER Steel Construction

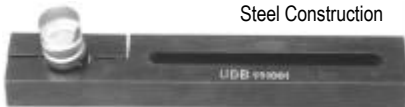

2	1	UDB-991048	SWIVEL BAR ASSY-SINGLE END-3/4" I.D. UNILOCK LINER Black Oxide Finish
---	---	------------	--

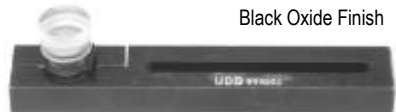

3	2	UDB-994832	1/2" AND 3/4" SWIVEL BAR ASSY-DOUBLE END-1/2 & 3/4 UNILOCK LINERS
---	---	------------	---

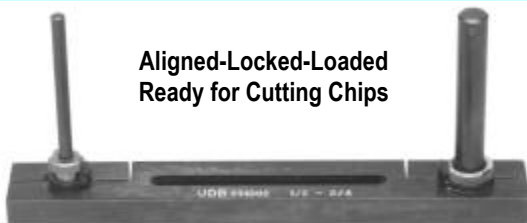

Aligned-Locked-Loaded
Ready for Cutting Chips

ITEM	QTY	PART NO.	DESCRIPTION
4	1	SB-32-20	UDB-BOMBSITE CENTER SPOTTER -1/2" O.D.
5	1	SB-48-20	UDB-BOMBSITE CENTER SPOTTER -3/4" O.D.



7/8" O.D.

1/2" O.D.



1-1/8" O.D.

3/4" O.D.

See Page C30.

18 SF-32-12(+ I.D.) x 1/2" O. D. x 3/4" LONG SLIP-FIXED RENEWABLE DRILL BUSHINGS WITH THE FOLLOWING I.D.s

ITEM	I.D.	ITEM	I.D.	ITEM	I.D.	ITEM	I.D.
6	#30 = .1285	11	3/16 = .1875	16	1/4 = .2500	21	5/16 = .3125
7	9/64 = .1406	12	#10 = .1935	17	F = .2570	22	21/64 = .3218
8	5/32 = .1562	13	13/64 = .2031	18	17/64 = .2656	23	11/32 = .3451
9	#20 = .1610	14	7/32 = .2187	19	9/32 = .2812		
10	11/64 = .1719	15	15/64 = .2344	20	19/64 = .2968		



SF32-12
1/2" O.D.



SF48-12
3/4" O.D.

See Pages A6-A7.

18 SF-48-12(+ I.D.) x 3/4" O. D. x 3/4" LONG SLIP-FIXED RENEWABLE DRILL BUSHINGS WITH THE FOLLOWING I.D.s

ITEM	I.D.	ITEM	I.D.	ITEM	I.D.	ITEM	I.D.
24	23/64 = .3594	29	7/16 = .4375	34	33/64 = .5156	39	19/32 = .5937
25	3/8 = .3750	30	29/64 = .4521	35	17/32 = .5312	40	39/64 = .6049
26	25/64 = .3906	31	15/32 = .4688	36	35/64 = .5469	41	5/8 = .6250
27	13/32 = .4062	32	31/64 = .4844	37	9/16 = .5625		
28	27/64 = .4219	33	1/2 = .5000	38	37/64 = .5781		

36 1 EACH--See P/Ns Below ALIGNMENT - CENTER PUNCHES

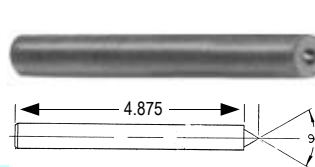

See Page M3.



ITEM	UNITED PART NO.	ITEM	UNITED PART NO.
42	UDB-141285 #30 .1285	60	UDB-143594 23/64" .3594
43	UDB-141406 9/64" .1406	61	UDB-143750 3/8" .3750
44	UDB-141562 5/32" .1562	62	UDB-143906 25/64" .3906
45	UDB-141610 #20 .1610	63	UDB-144062 13/32" .4062
46	UDB-141719 11/64" .1719	64	UDB-144219 27/64" .4219
47	UDB-141875 3/16" .1875	65	UDB-144375 7/16" .4375
48	UDB-141935 #10 .1935	66	UDB-144531 29/64" .4531
49	UDB-142031 13/64" .2031	67	UDB-144687 15/32" .4687
50	UDB-142187 7/32" .2187	68	UDB-144843 31/64" .4843
51	UDB-142344 15/64" .2344	69	UDB-145000 1/2" .5000
52	UDB-142500 1/4" .2500	70	UDB-145156 33/64" .5156
53	UDB-142570 "F" .2570	71	UDB-145312 17/32" .5312
54	UDB-142656 17/64" .2656	72	UDB-145469 35/64" .5469
55	UDB-142812 9/32" .2812	73	UDB-145625 9/16" .5625
56	UDB-142968 19/64" .2968	74	UDB-145781 37/64" .5781
57	UDB-143125 5/16" .3125	75	UDB-145937 19/32" .5937
58	UDB-143281 21/64" .3281	76	UDB-146094 39/64" .6049
59	UDB-143437 11/32" .3437	77	UDB-146250 5/8" .6250

78 1 UCC-994747-78 RIB-I STACKER CASE WITH FOAM INSERTS

Slip-Fit Renewable Bushing Swivel Bar Assemblies



FOR 5/16," 1/2" AND 3/4" SF BUSHINGS

SELECT YOUR SINGLE OR DOUBLE END SWIVEL DRILL BAR ASSEMBLY.

1. Select I.D. required. 2. Determine Slip-Fit Bushing. 3. Find Assembly number 4. You will receive the Swivel Adapters, UniLock Liners, Spotter, Transfer Punch and SF Bushings as a Total Assembly, unless specified otherwise. Items may also be purchased individually.

SINGLE END BAR WITHOUT SWIVEL ADAPTER UDB-991001

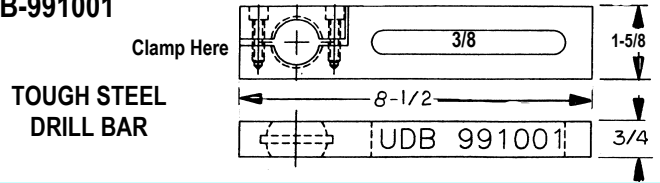

SINGLE END BARS WITH SWIVEL AND UNILOCK

SPECIFY UDB-991020 FOR 5/16" I.D. LINER
SPECIFY UDB-991032 FOR 1/2" I.D. LINER
SPECIFY UDB-991048 FOR 3/4" I.D. LINER

STEEL DRILL BAR

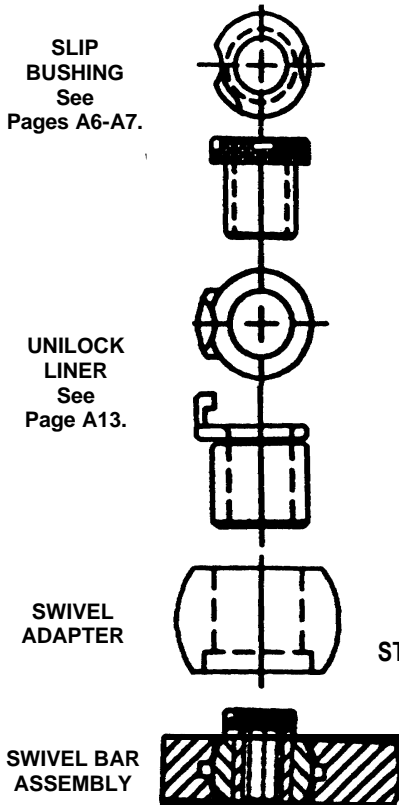

Swivels 15° to 20° in any direction.
Rotates 360°

DOUBLE END BAR WITHOUT SWIVEL ADAPTER UDB-991002

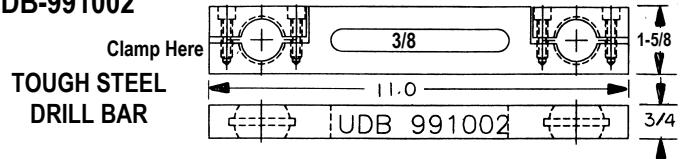

DOUBLE END BAR WITH SWIVEL AND UNILOCK LINER

SPECIFY UDB-992020-32 FOR 5/16" AND 1/2" LINERS in SAME BAR
SPECIFY UDB-992032-48 FOR 1/2" AND 3/4" LINERS in SAME BAR

STEEL DRILL BAR

SOCKET HEAD BOLTS ARE PROVIDED.



STEEL -- HEAT TREATED -- BLACK OXIDED

SLIP BUSHING SINGLE END BAR ASSY	SLIP BUSHING DOUBLE END BAR ASSY	SWIVEL ADAPTER	SWIVEL I.D.	UNILOCK LINER	CENTER SPOTTER	TRANSFER PUNCH	SLIP RENEWABLE BUSHING	DRILL RANGE	
								NOM.	ACTUAL
UDB-991020	UDB-992020	UDB-993032	1/2	UL-32-12 5/16	UDB-SB-20-20	UDB-143125	UDB-SF-20	#80 - #10	.0135 .1935
UDB-991032	UDB-992032	UDB-993048	3/4	UL-48-12 1/2	UDB-SB-32-20	UDB-145000	UDB-SF-32	#28 - 11/32	.1405 .3437
* UDB-991048	UDB-992048	UDB-993064	1.000	UL-64-16 3/4	UDB-SB-48-20	UDB-147500	UDB-SF-48	9/32 - 9/16	.2812 .5625

* FOR 1.000" I.D. SWIVEL, BAR IS 2" WIDE AND 1" HIGH.

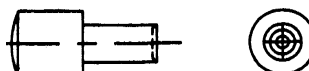
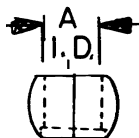

See page C30.

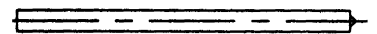

See page M3.

SWIVEL ADAPTERS		
PART NUMBER	A NOM.	DIA. ACTUAL
UDB-993032	1/2	.5000
UDB-993048	3/4	.7500
* UDB-993064	1.000	1.0000

BOMBSITE SPOTTERS	
PART NUMBER	B DIA.
SB-20-20	.3125
SB-32-20	.5000
SB-48-20	.7500

CENTER ALIGNMENT PUNCH		
PART NUMBER	A	DIA.
UDB-143125	5/16	.3125
UDB-145000	1/2	.5000
UDB-147500	3/4	.7500

Nurlock Adapter Tip Swivel Bar Assy

Nurlock Adapter Tip Swivel Drill Bar Assemblies

FOR 21000-22000-23000 SHANKS & LOCK SERIES

SINGLE END BAR WITHOUT SWIVEL ADAPTER

UDB-991001

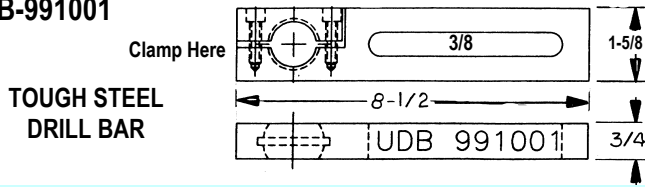

TOUGH STEEL
DRILL BAR

SELECT THE SINGLE OR DOUBLE END SWIVEL DRILL BAR ASSEMBLY NEEDED.

1. Select I.D. required.
2. Determine the Nurlock Shank I. D., O.D. and Lock Series. Add the required length numbers (Refer to Pages P10-P11 and Chart below).
3. Specify the Assembly number.
4. You will receive the selected Swivel Nurlock Liners, Spotter, Transfer Punch and Adapter Tips as a Total Assembly, unless specified otherwise. Items may also be purchased individually.

SINGLE END BAR WITH SWIVEL ADAPTER AND HELICAL NURLOCK LINERS

SPECIFY UDB-991124 FOR 3/8" I.D. LINERS. REFER TO CHART.
SPECIFY UDB-991128 FOR 7/16" I.D. LINERS. SEE BELOW.



Swivels
15° to 20°
in any
direction.

Rotates
360°

Nurlock
Adapter Tip
See Page P10

Nurlock Liner
See Page P32

Swivel Adapter

Nosepiece Ref.

Adapter Tip-
Nurlock Liner-
Swivel Bar Assy

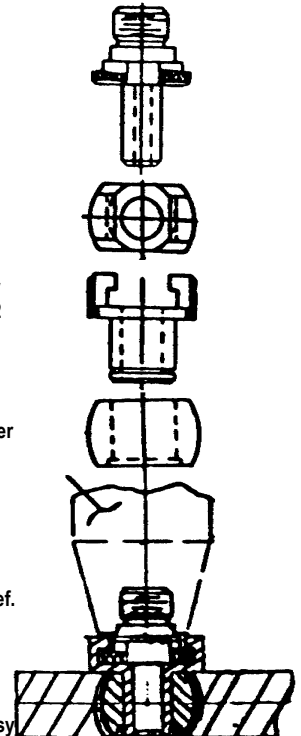

DOUBLE END BAR WITHOUT SWIVEL ADAPTER

UDB-991002

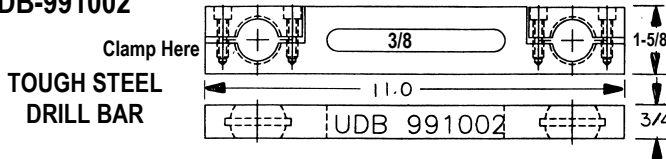

TOUGH STEEL
DRILL BAR

DOUBLE END BAR WITH SWIVEL ADAPTER AND HELICAL NURLOCK LINERS

SPECIFY UDB-992124-128 FOR 3/8" AND 7/16" LINERS in SAME BAR
SPECIFY UDB-992132-228 FOR 1/2" AND 7/16" LINERS in SAME BAR, ETC.

SOCKET HEAD BOLTS ARE PROVIDED.
STEEL -- HEAT TREATED -- BLACK OXIDED

TOUGH STEEL
DRILL BARS



NURLOCK SINGLE END BAR ASSY	NURLOCK DOUBLE END BAR ASSY	SWIVEL ADAPTER	SWIVEL I.D.	NURLOCK LINER	CENTER SPOTTER	TRANSFER PUNCH	NURLOCK SERIES ADAPTER TIP	DRILL RANGE	
								NOM.	ACTUAL
UDB-991124	UDB-992124	UDB-993032	1/2	UDB-HNL-213212 3/8	UDB-SB-24-20	UDB-143750	UDB-A211XX 3/8	3/32 - 1/4	.0937 -.2500
UDB-991128	UDB-992128	UDB-993048	3/4	UDB-HNL-21 4812 7/16	UDB-SB-28-20	UDB-144375	UDB-A212XX 7/16	3/32 - 5/16	.0937 -.3125
UDB-991132	UDB-992132	UDB-993048	3/4	UDB-HNL-21 4812 1/2	UDB-SB-32-20	UDB-145000	UDB-A213XX 1/2	3/32 - 3/8	.0937 -.3750
UDB-991228	UDB-992228	UDB-993048	3/4	UDB-HNL-224812 7/16	UDB-SB-28-20	UDB-144375	UDB-A221XX 7/16	3/16 - 9/32	.1875 -.2812
UDB-991232	UDB-992232	UDB-993048	3/4	UDB-HNL-22 4812 1/2	UDB-SB-32-20	UDB-145000	UDB-A222XX 1/2	3/16 - 11/32	.1875 -.3437
UDB-991236	UDB-992236	UDB-993052	13/16	UDB-HNL-225212 9/16	UDB-SB-36-20	UDB-145625	UDB-A223XX 9/16	3/16 - 13/32	.1875 -.4062
UDB-991240	UDB-992240	UDB-993056	7/8	UDB-HNL-225612 5/8	UDB-SB-40-20	UDB-146250	UDB-A224XX 5/8	3/16 - 15/32	.1875 -.4687
* UDB-991352	UDB-992352	UDB-993064	1.000	UDB-HNL-236416 13/16	UDB-SB-52-24	UDB-148125	UDB-A232XX 13/16	1/4 - 19/32	.2500 -.5938

* FOR 1.000 I.D. SWIVEL, BAR IS 2" WIDE AND 1" HIGH.

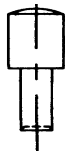

See page C30.

BOMBSITE SPOTTERS	
PART NUMBER	B DIA.
SB-24-20	.3750
SB-28-20	.4375
SB-32-20	.5000
SB-36-20	.5625
SB-40-20	.6250
SB-52-20	.8125

See page M3.

CENTER ALIGNMENT PUNCH	
PART NUMBER	A DIA.
UDB-143750 3/8	.3750
UDB-144375 7/16	.4375
UDB-145000 1/2	.5000
UDB-145625 9/16	.5625
UDB-146250 5/8	.6250
UDB-148125 13/16	.8125

SWIVEL ADAPTERS		
PART NUMBER	A NOM.	DIA. ACTUAL
UDB-993032	1/2	.5000
UDB-993048	3/4	.7500
UDB-993052	13/16	.8125
UDB-993056	7/8	.8750
* UDB-993064	1.000	1.0000

Helox Adapter Tip for Shelox Swivel Drill Bars

FOR HOLES TO 3/8" DRILLS

Helox-Shelox Swivel
Drill Bars

SELECT THE SINGLE OR DOUBLE END SWIVEL DRILL BAR ASSEMBLY NEEDED.

1. Select I.D. required. 2. Determine the Helox Shank I.D., O.D. on Pages Q27 – Q28. Add the required length numbers to the Helox Adapters. 3. Specify the Assembly number. 4. You will receive the selected Swivel Adapters, Liners, Spotter, Transfer Punch and Helox Adapter Tips as a Total Assembly, unless specified otherwise. Items may also be purchased individually.

HELOX ADAPTER TIP
SEE PAGES Q27-Q28.



SHELOX LINER
SEE PAGES Q30, Q35.

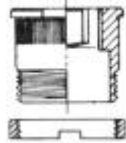

RETAINING RING
SEE PAGES Q30, Q35.

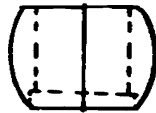

SWIVEL ADAPTER

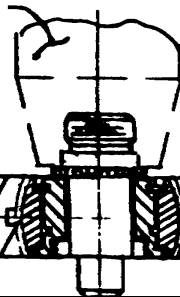

NOSEPIECE REF.
PAGES O-12 O-19.

HELOX ADAPTER TIP ASSEMBLY

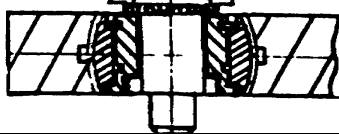

Swivels
15° to 20°
in any
direction.

Rotates
360°

SINGLE END BAR WITHOUT SWIVEL ADAPTER

UDB-991001

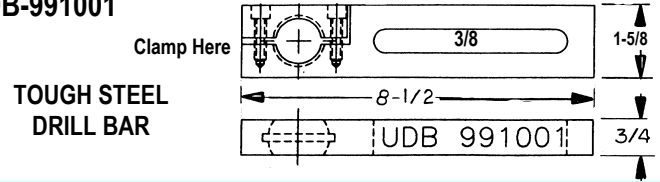

SINGLE END HELOX-SHELOX ADAPTER TIP BAR WITH SWIVEL

SPECIFY UDB-991492 FOR .2860 I.D. LINERS
SPECIFY UDB-991503 FOR .3906 I.D. LINERS
SPECIFY UDB-991515 FOR .5000 I.D. LINERS
SPECIFY UDB-991526 FOR .6250 I.D. LINERS



DOUBLE END BAR WITHOUT SWIVEL ADAPTER

UDB-991002

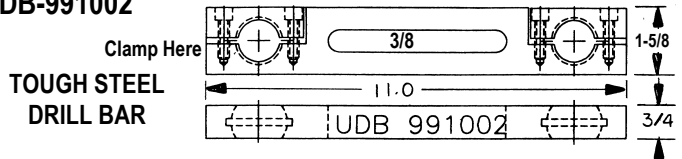

DOUBLE END HELOX-SHELOX ADAPTER TIP BAR WITH SWIVEL

SPECIFY UDB-992492-503 FOR .280 AND .390 LINERS in BAR
SPECIFY UDB-992515-526 FOR .500 AND .625 LINERS in BAR

SOCKET HEAD BOLTS ARE PROVIDED.
STEEL -- HEAT TREATED -- BLACK OXIDED

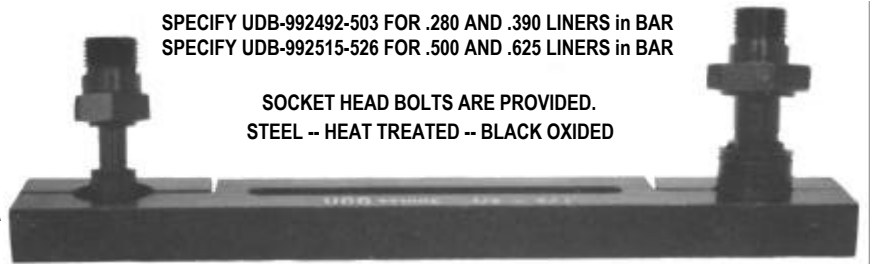

HELOX-SHELOX SINGLE END BAR ASSY	HELOX-SHELOX DOUBLE END BAR ASSY	SWIVEL ADAPTER	SWIVEL I.D.	SHELOX LINER	CENTER SPOTTER	TRANSFER PUNCH	HELOX ADAPTER TIP	DRILL RANGE	
								NOM.	ACTUAL
UDB-991492	UDB-992492	UDB-993032	1/2	UDB-521349 - .2860	UDB-SB-18-20	UDB-142800	UDB-A4900XX SERIES	1/16 - 7/64	.0625-.1094
UDB-991503	UDB-992503	UDB-993040	5/8	UDB-521350 - .3906	UDB-SB-25-20	UDB-143900	UDB-A5000XX SERIES	1/16 - 13/64	.0625-.2031
UDB-991515	UDB-992515	UDB-993050	7/8	UDB-521351 - .5000	UDB-SB-32-20	UDB-145000	UDB-A5100XX SERIES	1/16 - 5/16	.0625-.3125
* UDB-991526	UDB-992526	UDB-993064	1.00	UDB-521352 - .6250	UDB-SB-40-20	UDB-146250	UDB-A5200XX SERIES	1/16 - 23/64	.0625-.3594

* FOR 1.000 I.D. SWIVEL, BAR IS 2" WIDE AND 1" HIGH

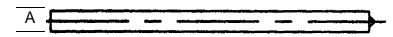
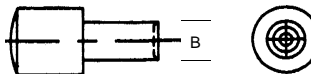
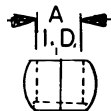

SWIVEL ADAPTERS		
PART NUMBER	A NOM.	DIA. ACTUAL
UDB-993032	1/2	.5000
UDB-993040	5/8	.6250
UDB-993050	7/8	.8750
* UDB-993064	1.000	1.0000

See page C30.

BOMBSITE SPOTTERS	
PART NUMBER	B DIA.
SB-18-20	.2860
SB-25-20	.3906
SB-32-20	.5000
SB-40-20	.6250

See page M3.

CENTER ALIGNMENT PUNCH		
PART NUMBER	A DIA.	
UDB-142800	.280	.2860
UDB-143900	.390	.3906
UDB-145000	1/2	.5000
UDB-146250	5/8	.6250

12-03-03

AT Adapter Tip Series Drill Bars

AT Adapter Tip & LL Lock Liner Series Drill Bar Assy

SINGLE END BAR WITHOUT SWIVEL ADAPTER

UDB-991001

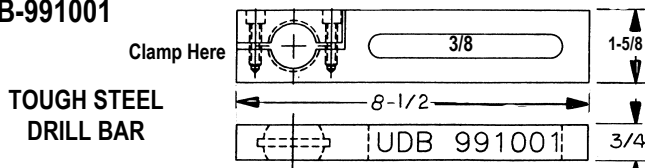

**TOUGH STEEL
DRILL BAR**

SELECT THE SINGLE OR DOUBLE END SWIVEL DRILL BAR ASSEMBLY.

1. Select I.D. required.
2. Determine the AT Shank I. D. and O.D. Adapter Tip. See Page P45. Add the required length numbers to the AT Adapters.
3. Specify the Assembly number.
4. You will receive the selected Swivel Adapters, Lock Liners, Spotter, Transfer Punch and AT Adapter Tips as a Total Assembly, unless specified otherwise. Items may also be purchased individually.

SINGLE END AT ADAPTER TIP DRILLBAR WITH LOCK LINER

SPECIFY UDB-991622 FOR 11/32 I.D. LINER
SPECIFY UDB-991628 FOR 7/16 I.D. LINER
SPECIFY UDB-991636 FOR 9/16 I.D. LINER
SPECIFY UDB-991648 FOR 3/4 I.D. LINER



DOUBLE END BAR WITHOUT SWIVEL ADAPTER

UDB-991002

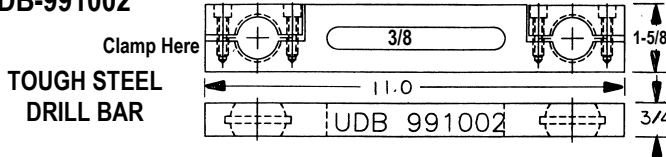

**TOUGH STEEL
DRILL BAR**

**Swivels
15° to 20°
in any
direction.**

**Rotates
360°**

AT SERIES
ADAPTER TIP
SEE PAGE P41.

LL SERIES
LINER
SEE PAGE P41.

SWIVEL
ADAPTER

NOSEPIECE
REF.
SEE PAGES
O-12 O-19.

AT ADAPTER
ASSEMBLY

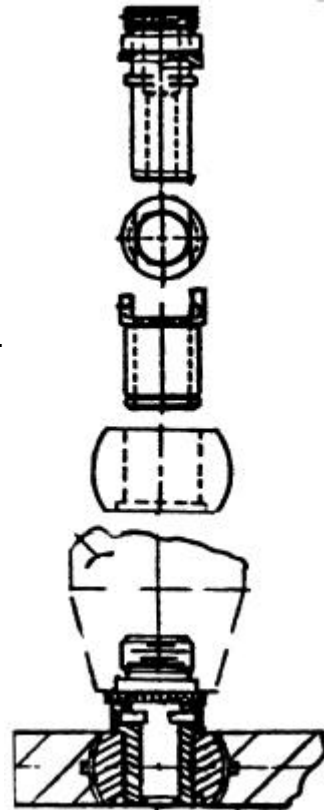

DOUBLE END AT ADAPTER TIP DRILLBAR WITH TWO LOCK LINERS OF YOUR CHOICE.

SPECIFY UDB-992622-28 FOR 11/32" AND 7/16" LINERS in SAME BAR
SPECIFY UDB-992636-48 FOR 9/16" AND 3/4" LINERS in SAME BAR

SOCKET HEAD BOLTS ARE PROVIDED.

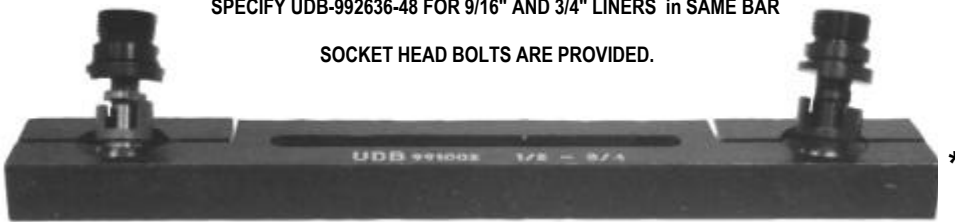

STEEL -- HEAT TREATED -- BLACK OXIDED

AT SERIES SINGLE END BAR ASSY	AT SERIES DOUBLE END BAR ASSY	SWIVEL ADAPTER	SWIVEL I.D.	LL LOCKING LINER	CENTER SPOTTER	TRANSFER PUNCH	AT TYPE ADAPTER TIP	DRILL RANGE	
								NOM.	ACTUAL
UDB-991622	UDB-992622	UDB-993036	9/16	UDB-LL-36-12P 11/32	UDB-SB-22-20	UDB-143437	UDB-AT-22-XX I.D.	3/16 - #5	.1875-.2055
UDB-991628	UDB-992628	UDB-993044	11/16	UDB-LL-44-12P 7/16	UDB-SB-28-20	UDB-144375	UDB-AT-28-XX I.D.	#11 - 9/32	.1910-.2812
UDB-991636	UDB-992636	UDB-993052	13/16	UDB-LL-52-12P 9/16	UDB-SB-36-20	UDB-145625	UDB-AT-36-XX I.D.	9/32 - Z	.2812-.4130
UDB-991648	UDB-992648	UDB-993064	1.000	UDB-LL-64-14P 3/4	UDB-SB-48-20	UDB-147500	UDB-AT-48-XX I.D.	9/32 - 5/8	.2812-.6250

* FOR 1.000 I.D. SWIVEL, BAR IS 2" WIDE AND 1" HIGH.

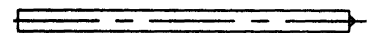
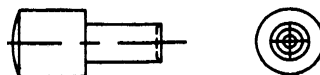
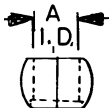

SWIVEL ADAPTERS		
PART NUMBER	A NOM.	DIA. ACTUAL
UDB-993036	9/16	.5625
UDB-993044	11/16	.6875
UDB-993052	13/16	.8125
UDB-993064	1.000	1.0000

See page C30

BOMBSITE SPOTTERS	
PART NUMBER	B DIA.
SB-22-20	.3437
SB-28-20	.4375
SB-36-20	.5625
SB-48-20	.7500

See page M3.

CENTER ALIGNMENT PUNCH		
PART NUMBER	A	DIA.
UDB-143437	11/32	.3437
UDB-144375	7/16	.4375
UDB-145625	9/16	.5625
UDB-147500	3/4	.7500